

Conjunto "KITS" de conectores estancos serie XBDT

Conectores macho

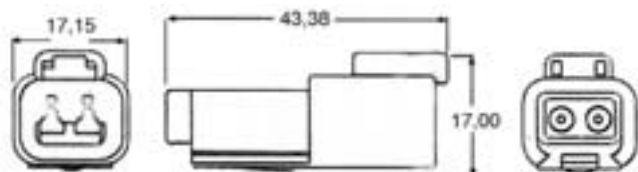

XBDT-04-2P

2 vías

☞ : 1 / 10

Conectores hembra

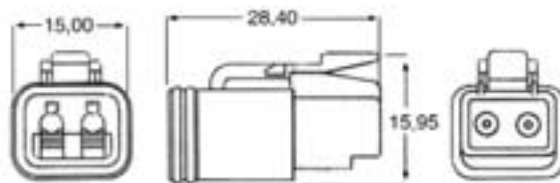

XBDT-06-2S

2 vías

☞ : 1 / 10

Conectores macho

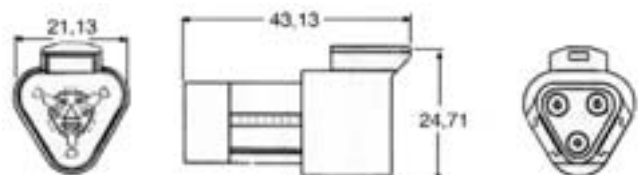

XBDT-04-3P

3 vías

☞ : 1 / 10

Conectores hembra

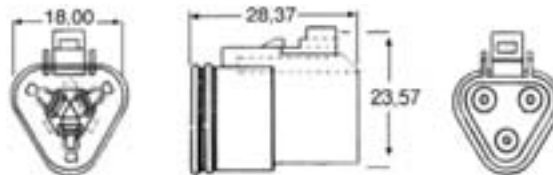

XBDT-06-3S

3 vías

☞ : 1 / 10

Conectores macho

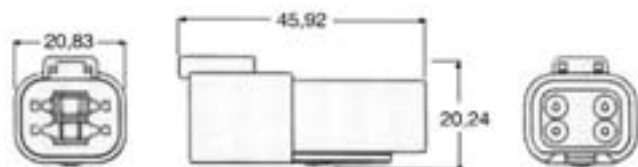

XBDT-04-4P

4 vías

☞ : 1 / 10

Conectores hembra

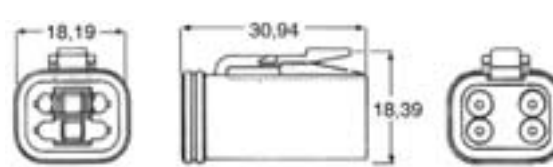

XBDT-06-4S

4 vías

☞ : 1 / 10

Conjunto "KITS" de conectores estancos serie XBDT

Conectores macho

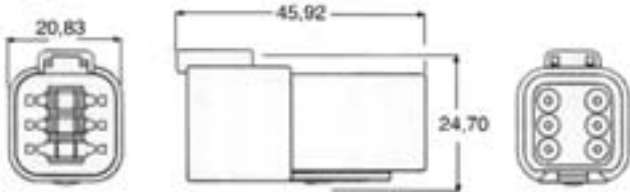

XBDT-04-6P

6 vías

☞ : 1 / 10

Conectores hembra

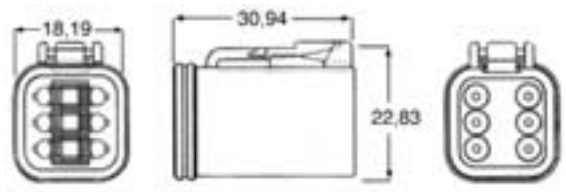

XBDT-06-6S

6 vías

☞ : 1 / 10

Conectores macho

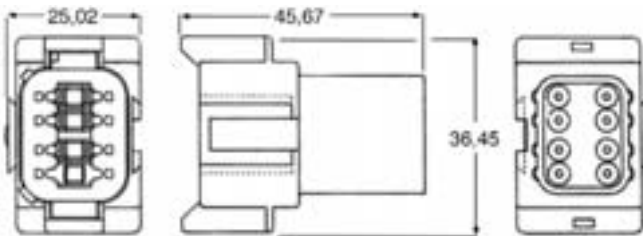

XBDT-04-8PA

8 vías

☞ : 1 / 10

Conectores hembra

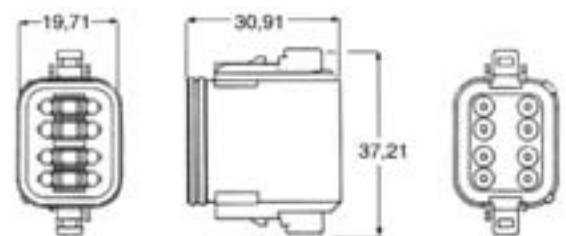

XBDT-06-8SA

8 vías

☞ : 1 / 10

Conectores macho

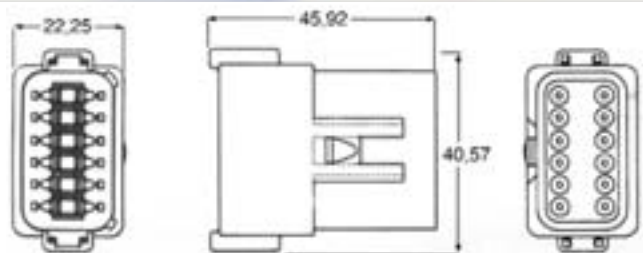

XBDT-04-12PA

12 vías

☞ : 1 / 10

Conectores hembra

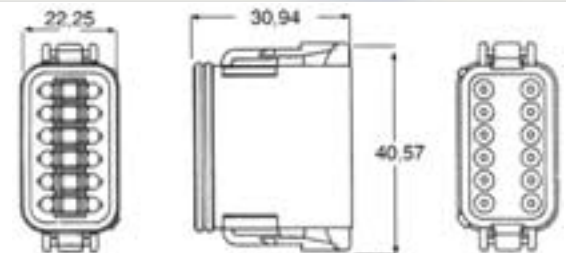

XBDT-06-12SA

12 vías

☞ : 1 / 10

Conectores estancos serie XBDT

REFERENCIAS UNITARIAS DE CONECTORES, SECONDARYLOCK Y TERMINALES

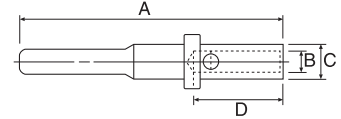

Conector macho	Nº vías	Secondarylock	Terminal macho	Dimensiones terminal mm.				
				A	B	C	D	
DT-04-2P	2	W2P	0,5 ~ 1,0	460202.16141	20,85	1,68	2,62	6,35
			1,0 ~ 2,0	460215.16141	20,85	1,93	2,62	6,35
DT-04-3P	3	W3P	0,5 ~ 1,0	460202.16141	20,85	1,68	2,62	6,35
			1,0 ~ 2,0	460215.16141	20,85	1,93	2,62	6,35
DT-04-4P	4	W4P	0,5 ~ 1,0	460202.16141	20,85	1,68	2,62	6,35
			1,0 ~ 2,0	460215.16141	20,85	1,93	2,62	6,35
DT-04-6P	6	W6P	0,5 ~ 1,0	460202.16141	20,85	1,68	2,62	6,35
			1,0 ~ 2,0	460215.16141	20,85	1,93	2,62	6,35
DT-04-8PA	8	W8PA	0,5 ~ 1,0	460202.16141	20,85	1,68	2,62	6,35
			1,0 ~ 2,0	460215.16141	20,85	1,93	2,62	6,35
DT-04-12PA	12	W12PA	0,5 ~ 1,0	460202.16141	20,85	1,68	2,62	6,35
			1,0 ~ 2,0	460215.16141	20,85	1,93	2,62	6,35

: 100

: 100

: 500

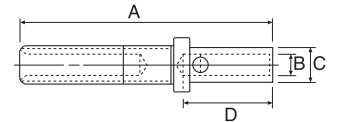

Conector hembra	Nº vías	Secondarylock	Terminal hembra	Dimensiones terminal mm.				
				A	B	C	D	
DT-04-2S	2	W2S	0,5 ~ 1,0	462201.16141	19,28	1,68	2,62	6,35
			1,0 ~ 2,0	462209.16141	19,23	1,93	2,62	6,35
DT-04-3S	3	W3S	0,5 ~ 1,0	462201.16141	19,28	1,68	2,62	6,35
			1,0 ~ 2,0	462209.16141	19,23	1,93	2,62	6,35
DT-04-4S	4	W4S	0,5 ~ 1,0	462201.16141	19,28	1,68	2,62	6,35
			1,0 ~ 2,0	462209.16141	19,23	1,93	2,62	6,35
DT-04-6S	6	W6S	0,5 ~ 1,0	462201.16141	19,28	1,68	2,62	6,35
			1,0 ~ 2,0	462209.16141	19,23	1,93	2,62	6,35
DT-04-8SA	8	W8SA	0,5 ~ 1,0	462201.16141	19,28	1,68	2,62	6,35
			1,0 ~ 2,0	462209.16141	19,23	1,93	2,62	6,35
DT-04-12SA	12	W12SA	0,5 ~ 1,0	462201.16141	19,28	1,68	2,62	6,35
			1,0 ~ 2,0	462209.16141	19,23	1,93	2,62	6,35

: 100

: 100

: 500

Conectores estancos serie XBDT



HDT-48-00

Herramientas para engaste de terminales.

 : 1



0411.204.1605

Útil para la extracción de terminales

 : 1



Conectores estancos

“SUPER SEAL” SERIE 1,5 mm.

Material: PA 66

Terminal macho



SERIE 1,5 SUPERSEAL

Ref.	Sección cable mm ²	Dimensiones mm.	
11.05530-32	0,3-0,5	1,5 x 7 x 22,7	100
11.05550-32	1-1,5	1,5 x 7 x 22,7	100

Terminal hembra



SERIE 1,5 SUPERSEAL

Ref.	Sección cable mm ²	Dimensiones mm.	
11.05540-32	0,3-0,5	1,5 x 7 x 16,5	100
11.05560-32	1-1,5	1,5 x 7 x 16,5	100

Para terminal macho



■ **44.23610** 1 vía

: 10 / 100

Para terminal hembra



■ **44.23620** 1 vía

: 10 / 100

Para terminal macho



■ **44.23630** 2 vías

: 10 / 100

Para terminal hembra



■ **44.23640** 2 vías

: 10 / 100

Conectores estancos - "SUPER SEAL" SERIE 1,5 mm.

Para terminal macho

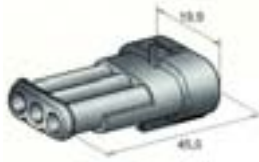

■ 44.23650 3 vías

☞ : 10 / 100

Para terminal hembra



■ 44.23660 3 vías

☞ : 10 / 100

Para terminal macho

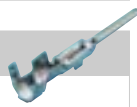

■ 44.23670 4 vías

☞ : 5 / 50

Para terminal hembra



■ 44.23680 4 vías

☞ : 5 / 50

Para terminal macho



■ 44.23690 5 vías

☞ : 5 / 50

Para terminal hembra



■ 44.23700 5 vías

☞ : 5 / 50

Para terminal macho



■ 44.23710 6 vías

☞ : 5 / 50

Para terminal hembra



■ 44.23720 6 vías

☞ : 5 / 50

Conectores estancos - "SUPER SEAL" SERIE 1,5 mm.



■ **44.23470** 2 vías

📦 : 10 / 100



■ **44.23355** 3 vías

📦 : 5 / 50



SERIE 1,5 SUPERSEAL

Ref.	Ø aislante mm.	Material	Color	📦
44.07510	1,4-1,7	Silicona	■	50



SERIE 1,5 SUPERSEAL

Ref.	Ø aislante mm.	Material	Color	📦
44.07530	2,6-3,3	Silicona	■	50

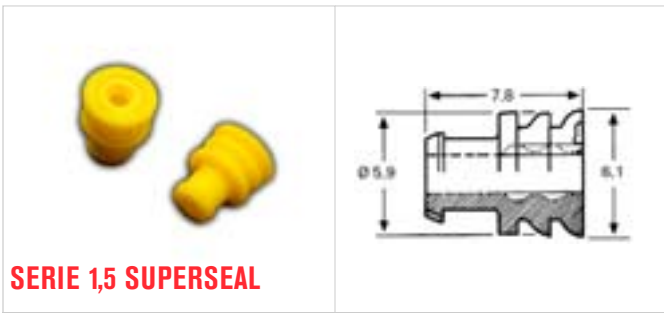

SERIE 1,5 SUPERSEAL

Ref.	Ø aislante mm.	Material	Color	📦
44.07740	1,8-2,4	Silicona	■	50

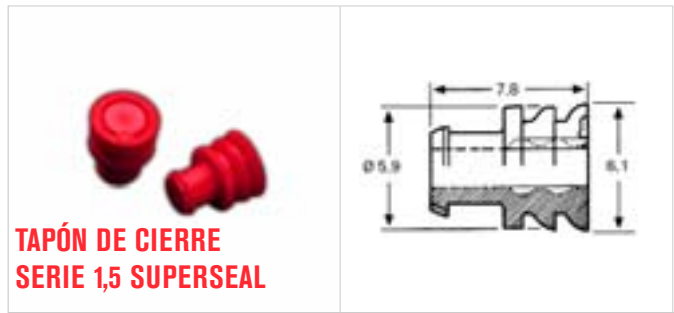

**TAPÓN DE CIERRE
SERIE 1,5 SUPERSEAL**

Ref.	Ø aislante mm.	Material	Color	📦
44.10659	Tapón de cierre	Silicona	■	50

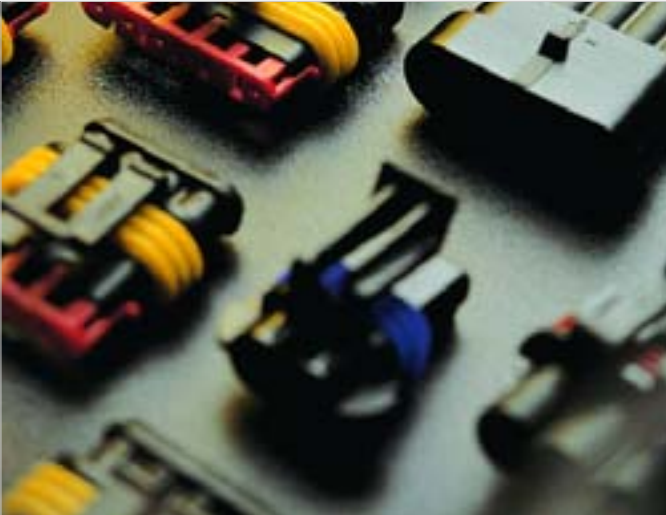

Conectores estancos

“SUPER SEAL” SERIE 2,8 mm.

Terminal hembra	Ref.	Sección cable mm ²	Dimensiones mm.	
	11.04510-32	0,5-1,5	2,8x8,7x19,9	50
	11.04530-32	1,5-2,5	2,8x8,7x19,9	50
Terminal macho	Ref.	Sección cable mm ²	Dimensiones mm.	
	11.04500-32	0,5-1,5	2,8x3,82x32,7	50
	11.04520-32	1,5-2,5	2,8x3,82x32,7	50

Para terminal macho

■ **44.23520** 1 vía

Para terminal hembra

■ **44.23510** 1 vía

Para terminal macho

■ **44.23540** 2 vías

Para terminal hembra

■ **44.23530** 2 vías

Para terminal macho

■ **44.23560** 3 vías

Para terminal hembra

■ **44.23550** 3 vías

Conectores estancos - "SUPER SEAL" SERIE 2,8 mm.

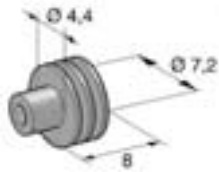

SERIE 2,8 SUPERSEAL

Ref.	Ø aislante mm.	Material	Color	
44.33561	1,29-2,06	Silicona	■	50

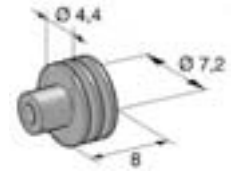

SERIE 2,8 SUPERSEAL

Ref.	Ø aislante mm.	Material	Color	
44.33559	2,8-3,5	Silicona	■	50

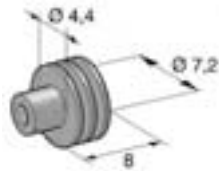

SERIE 2,8 SUPERSEAL

Ref.	Ø aislante mm.	Material	Color	
44.33558	1,5-2,4	Silicona	■	50

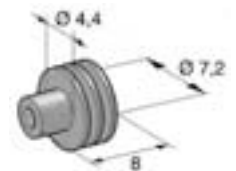

SERIE 2,8 SUPERSEAL

Ref.	Ø aislante mm.	Material	Color	
44.33560	3,5-4,21	Silicona	■	50

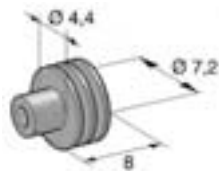

SERIE 2,8 SUPERSEAL

Ref.	Ø aislante mm.	Material	Color	
44.33562	2,03-2,8	Silicona	■	50

KIT conector estanco - "SUPER SEAL" SERIE 6,3 mm.

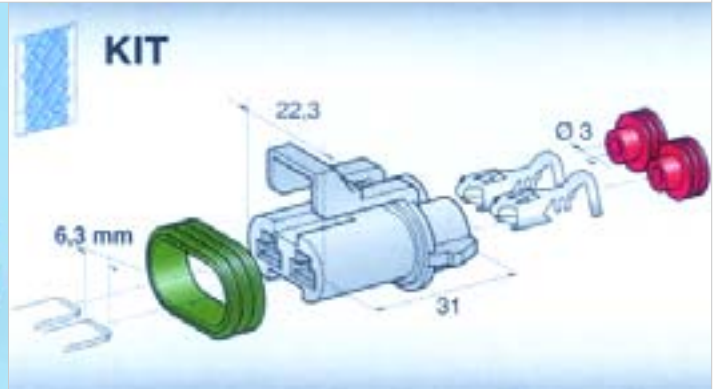

■ **44.33800**

2 vías. Material: PA 66. Terminales: Bronce fosforoso estañado.

Sección cable: 1.0~2.0 mm²

📦 : 1 / 250

KIT de puerta, con conectores y terminales

■ **30.50141**

KIT PARA PUERTA TRASERA



Material: PA 66 - 6F

Conector con Secondarylock1 u.

Terminal Ref. **11.08420**10 u.

Gomino Ref. **44.10658**10 u.

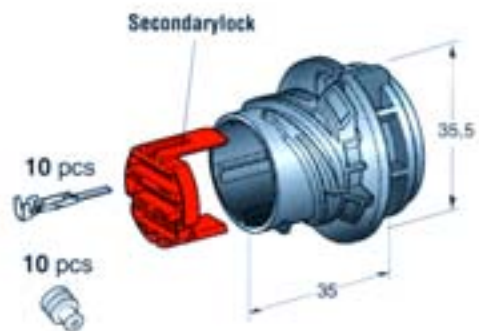

■ **30.50140**

KIT PARA PUERTA DELANTERA



Material: PA 66 - 6F

Conector con Secondarylock1 u.

Terminal Ref. **11.08410**29 u.

Gomino Ref. **44.10658**29 u.

